

Sewers for Adoption 7th Edition Pumping Station Addendum June 2014

Update Log: *Latest updates shown in red text*

Version Nr	Date	Comments
v1.6	17 Jun 2014	New document to align with new Sewers For adoption 7 th Edition (updated on iDocs on 21/08/2015 and emailed for updating on http://sfa.wrcplc.co.uk/sfa7-supporting-documents.aspx website to denise.bennett@wrcplc.co.uk)
v1.5	05 Aug 2013	Part 3A – Sec 3.3.16.1 updated
v1.4	16 Dec 2011	Updated document - Dec2011 version (Version number - under 'Revision' column changed on 16/12/2011 - previously known as "Dec 2011 Version")
v1.3	12 Oct 2010	Updated document - Aug2010 version (Version number - under 'Revision' column changed on 11/11/2011 - previously known as "Aug 2010 Version")
v1.2	11 Dec 2009	Document moved from SC stds DB. Updated to Dec 08 version (Version number - under 'Revision' column changed on 11/11/2011 - previously known as "Dec 08 Version")
v1.1	27 Mar 2008	Updated document from WRc Website (Version number - under 'Revision' column changed on 11/11/2011 - previously known as "Jan 08 Version")
v1.0	15 May 2007	New document (Version number - under 'Revision' column changed on 11/11/2011 - previously known as "Oct 06 Version")

CONTENTS:

PURPOSE

PART A – GENERAL *No additional comments*

PART B – DESIGN & CONSTRUCTION OF NEW FOUL SEWERS & LATERAL DRAINS
No additional comments

PART C – SURFACE WATER SEWERS & LATERAL DRAINS *No additional comments*

PART D - PUMPING STATIONS *additional comments*

PART E – CIVIL ENGINEERING SPECIFICATION *additional comments*

PART F – MECHANICAL & ELECTRICAL SPECIFICATION FOR SMALL PUMPING STATIONS *additional comments*

PURPOSE

This Addendum details where Severn Trent Water requirements for sewage pumping stations differ from those specified in Sewers For Adoption 7th Edition (SFA7). The Addendum should be used in conjunction with the SFA7 document where the Developer wishes to design and construct a sewage pumping station for inclusion within an Adoption Agreement.

Developers are encouraged to engage with Severn Trent Water at an early stage in a project to discuss site specific details.

Severn Trent Water standard pumping station template drawings are available on request.

PART A – GENERAL

No additional comments

PART B – DESIGN & CONSTRUCTION OF NEW FOUL SEWERS & LATERAL DRAINS

No additional comments

PART C – SURFACE WATER SEWERS & LATERAL DRAINS

No additional comments

PART D - PUMPING STATIONS

D3 GENERAL

- D3.1** Severn Trent Water require documented evidence of calculations used to select a pumped solution in preference to a gravity system.
- D3.2.a** Land drainage must not directly or indirectly connect to the proposed adoptable surface water sewer network and be provided with sufficient flood protection to prevent it entering into it in an extreme event.
- D3.3** Special consideration should be given to the design of terminal pumping stations delivering directly to a treatment works or where the discharge point is close enough to the works for there to be no attenuation in the gravity sewer upstream of the works. Developers are advised to open discussions with the Undertaker as early as possible.

D4 PROVISION OF PUMPING STATIONS

D4.1 Location

D4.1.2 Since the impact of any resultant flooding is greater, then for critical sites, the proposed adoptable gravity surface water sewers discharging to the station may have to be designed for the 1:5 year storm event.

D4.2 Site Access

D4.2.2a Access from public highway - To aid safe and reasonable vehicular access to pumping stations there are preferred layouts with minimum dimensions for the following situations.

- Pumping station off road with integral turning head – Layout A
 - Pumping station compound off road – Layout B
- Details are available from Severn Trent Water

D4.2.2b Access Roads - Where a new dedicated access road is being constructed then the preference is that the road is owned by Severn Trent Water. The access road shall conform to the necessary requirements of the Highway and Planning Authorities

D4.2.2c The minimum layout requirements for a site which will be served by large rigid and articulated vehicles are as follows:-
Road Width on straight single track roads is 4.0m internal radius of bends is 10.5 m

D4.2.2d Gradients and cross falls should be provided within the following ranges:-
Maximum road gradient is 1 in 15
Maximum cross fall is 1 in 30
Optimum cross fall is 1 in 40
Minimum cross fall is 1 in 50 (or 1 in 60 for concrete roads)
Maximum gradient within 15 m of highway is 1 in 30 (to be agreed with Highway Authority)

D4.2.2e Gates – should not open on to the highway. If the approach is straight then the gates should be 4.0 m wide minimum. For openings over 4.0m wide double gates must be provided

D4.2.2f Concrete roads – In all cases Grade PAV2 air entrained concrete shall be used to provide adequate frost resistance. It is essential that the concrete mix does NOT contain PFA.

D4.3 Layout of Pumping Stations

D4.3.1 Pumping Station layout - To accommodate rigid body 4,000 gallon tankers the preferred minimum size of the compound needed is 14m x 11.35m with

4m wide gates. Where the compound has an integral turning head then size needed is 29.5m x 17.5 m

D4.3.2 Fencing - Subject to local planning approval, Severn Trent Water standard requirement is for sites to be enclosed with 1.8 m high expanded metal panel fencing or alternatively an equivalent brick wall with gates secured by padlocked slide bolt or similar. Gates should provide the same degree of protection as the adjacent fencing. Where the above requirement cannot be met either in order to satisfy specific local planning approval or other environmental and amenity considerations selection of suitable perimeter fencing for the site will be based upon a risk assessment. Details are available from Severn Trent Water New Connections Team: new.connections@severntrent.co.uk Tel: 0800 707 6600

D4.3.6 Severn Trent Water shall be consulted to discuss the provision of safe parking

D4.4 Kiosk Positioning

D4.4.1.d) There shall be 1m clear space between the open kiosk doors and the wet well to ensure a safe walkway

D4.5 Storage

D4.5.1a The SPS shall be capable of pumping the entire storm and be provided with stand by pumps and control panels or be capable of storing the entire storm in the event of pump or plant failure.

D4.5.1b The system must not flood in the 1:30 year event. In exceptional circumstances provision of storage for the 1:100 year event may be considered for adoption. However this is not preferred by Severn Trent Water. The effectiveness of proposed flood routing must be demonstrated and approved by Severn Trent Water.

D4.5.1c Emergency overflows are not required on new foul water pumping stations.

D4.6 Hydraulic Design of Pumping Stations

D4.6.1 For large SPS with high discharge rates it may be necessary to prove performance of their proposed design by undertaking scaled hydraulic modelling of the SPS wet well and pump configuration by a specialist consultant in this work.

D4.7 Pumping Station Design

D4.7.1a Severn Trent Water will not adopt WIS 4-04-01 or WIS 4-04-02 designs. For Type 1 & Type 2 installations Severn Trent Water support the use of package pumping stations which satisfy the following criteria:

- MDPE wet well construction (GRP shall not be used)
- A separate valve chamber shall be provided – valves shall not be located in the wet well
- Pump stools (duckfoot) shall be fixed by captive studs which enable the stool to be removed/replaced from inside the well. These studs should be able to be replaced.

D6 DESIGN OF PUMPING STATIONS

D6.1 General

D6.1.1 Pumping stations must be fail safe in operation in the event of pump or plant failure. A generator connection shall be provided.

D6.1.6 In some instances provision of adequate raked coarse screens and grit separators may be needed.

D6.2 Hazardous Areas

D6.2.1 The hazardous (potentially explosive atmosphere) Zone classification of wet wells to pumping stations shall be determined by means of a non calculable approach used to better understand the likelihood of a Potentially Explosive Atmosphere forming from the entry into sewers of flammable substances stored and used within the catchment. It is known as Catchment Area Analysis (CAA) assessment. Buildings and kiosks containing electrical equipment shall be isolated from chambers falling into any Zone classification. The equipment in them should be designed to comply with their Zone classification. The CAA assessment should be undertaken prior to the design stage to determine whether explosive proof equipment is required. The CAA is used to determine if a catchment is Normal or Higher Risk.

Where no existing flow is routed through the new development and there will be no significant volumes of flammable substances stored in that development then the presumption is that the CAA will give a Normal Risk classification. In this instance the hazardous zone is designated as ST-Zone BZ. This is the name used to describe the minimum non statutory design standard applied to sewerage assets. The standard determines a minimum standard for equipment installed into areas that are exposed to a sewage derived atmosphere that has a likelihood of forming a PEA which is less than the statutory Zone 2.

If the existing sewage flow is to be diverted through the new development site then the developer must consult with Sewerage Asset Protection who will then undertake the CAA assessment in order to determine whether the catchment risk is Higher or Normal and thus designate the hazardous zone classification.

D6.3 Wet Well – General

D6.3.1 When designing the gravity foul sewer network the developer should note that the preferred maximum depth of the wet well, from ground cover level to the underside of the pumpset is 7 m. For depths exceeding this then an auxiliary suction pipe may be needed.

D6.3.2 A stainless steel baffle plate must be provided with a nylon rope, used to lift the baffle plate to clear any material trapped between the plate and inlet pipe, looped through the baffle plate and attached to a stainless steel parking bracket self anchored to the concrete edge of the clear opening.

D6.3.5 If a separate storage/inlet chamber is provided upstream of the wet well then it must be located in the compound and in an area where safe access for maintenance can be provided. The chamber shall be provided with a penstock and fixed tank emptying suction pipe of 100 mm diameter set 500 mm above the invert of the chamber and rising 900mm above ground level to the centre line of this suction pipe. It needs to terminate with a 90degree bend and a male Bauer coupling. The penstock must have an extension spindle capable of being operated at ground level. If a larger wet well is used instead of an inlet chamber the penstock should be located in the wet well.

D6.3.6 A vertical stainless steel ladder shall be provided for man entry into the wet well. It is to be located, centrally, opposite the pump guide rails with the top of the ladder fixed to the concrete edge of the clear opening to the well. Retractable handposts are to be provided either side of the ladder, self anchor bolted to the concrete edge of the clear opening.

D6.4 Wet Well – Structural Design

D6.4.1 If a wet well constructed from MDPE is proposed, prior approval by Severn Trent Water is required. GRP wet wells should not be used.

D6.4.2 Flotation – The minimum factor of safety against flotation for empty structures subject to groundwater pressure is 1.1 as outlined in BS8007:1987. This should only be used where the maximum groundwater level can be assessed accurately or a design groundwater level at finished ground level is being used.

D6.4.4 In situ reinforced concrete – the minimum cover should not be less than 40 mm provided this meets the requirements of BS8500 -1:2006 and BRE

SD1. All concrete water retaining/excluding structures shall be designed to satisfy cracking requirements for flexural and thermal loading. The standard concrete mix based upon BS8500 is C28/35 – general water retaining (and water excluding) structural applications. Reinforcement shall be designation H high yield steel with a design stress of 500 N/mm².

D6.4.8 When using a MDPE wet well the foundation slab and backfill should be constructed in accordance with manufacturer's guidance. In locations with high water tables, all necessary measures should be taken to prevent flotation and to ensure the MDPE is of sufficient thickness to resist deformation.

D6.5 Valve Chamber

D6.5.3c The female Bauer coupling over pumping pipe to terminate with a 90 degree horizontal bend, 900 mm above the valve chamber cover to centre line of the over pumping

D6.5.4 Severn Trent Water preference is that the discharge from the drain is by a penstock. A flap valve in the well is not acceptable.

D6.5.5 Extension spindles and hand wheels shall be fitted where appropriate to facilitate operation of the valves in the event of the valve chamber being flooded.

D6.5.7 Wherever possible the depth of the valve chamber from ground level to floor of the chamber should not exceed 1.5m. The minimum depth should not be less than 0.95m

D6.6 Flow Metering

D6.6.1 Severn Trent Water require a flowmeter to be provided on all Type 3 & 4 pumping stations. The flowmeter shall:

- Monitor discharge performance
- Alarm, and change pump duty in the event of no flow conditions (e.g. partial blockage)

D6.6.2 The chamber shall be a minimum of 1200 mm diameter, located near to the valve chamber. It shall include

- A flowmeter positioned in accordance with the manufacturer's recommendations
- A rising main isolation valve (T-key operated)
- A 100 mm diameter drain to the valve chamber

On secure compounds the cover to comprise bolted down open grid flooring.

D6.7 Access into Wet Well, Valve Chambers & Flow Meter Chambers

D6.7.1 Severn Trent Water preference is that open mesh decking be utilised over the whole valve chamber. Maximum loading to be 500kg/m. Mesh decking to be provided with holes or slots to allow operation of valves from ground level. Standard details for mesh decking flooring are available from Severn Trent Water.

D6.7.2d Cover and frame to wet well, if subject to traffic loading from maintenance vehicles, be FACTA Class C loading

D6.7.2de The safety grid to be provided with a 225 mm dia slot to allow suction hose to pass through

D6.11 Kiosk Construction

D6.11.7 The Developer should seek advice from Severn Trent Water on expected vandalism levels and Electro Magnetic Conductivity (emc) levels.

D6.11.9 Kiosk Colour: Alternative colours shall be provided where required by the Planning Authority.

D6.11.12a A lockable storage kiosk for storing barriers, davit and winch equipment shall be provided. The door to the storage kiosk to have the same locking and hinge arrangements as the doors to the motor control panel kiosk.

D6.11.13 The generator cat flap shall be installed on the side walls of the kiosk not in the doors.

D6.11.14 The kiosk doors shall be fitted with a cylinder type locks.

PART E – GENERAL

No additional comments

PART F - M & E SPECIFICATION FOR PUMPING STATIONS

Severn Trent Water has a number of Framework Agreement purchasing arrangements for the supply of pump/motor sets and motor control panels.

Whilst there is no obligation upon Developers to use these Framework Suppliers, it may be advantageous to procure M&E equipment from these suppliers since the products are of an acceptable quality/specification for adoption.

The current list of relevant Framework Suppliers can be obtained from Severn Trent Water New Connections Team: new.connections@severntrent.co.uk
Tel: 0800 707 6600

F1 GENERAL

F1.1 Hazardous area appliances

F1.1.1 For sewage pumping stations designated as ST –Zone BZ only low risk equipment shall be used. Examples are float switches, submersible pumps, ultrasonic level detectors and proximity switches. The equipment shall be non-sparking.

Equipment requirements for ST-Zone BZ are based upon the concept of low risk equipment in that:-

1. For electrical equipment, this shall only include equipment, which under normal operating conditions, does not increase its surface temperature, does not have opening or closing contacts or does not have exposed conductors with minimal risk of “ sparking “.
2. Motors are not normally exposed to air or to gas atmospheres above the liquid or where they are they do not include opening/closing contacts.
3. For mechanical equipment, this shall only include equipment which under normal operating conditions does not:
 - increase its surface temperature appreciably
 - have opening and closing contacts
 - have impacting items or devices

A non electrical assessment based on EN 15198 and EN13463 – 1:2001 for ignition sources in normal operation should be undertaken where applicable/possible.

4. All equipment must be earthed and earth bonded.
5. All equipment must have minimal capacity or capability for producing static.
6. Mechanical equipment such as bearings, seals and mechanical piece parts operating slowly and in a damp or wet environment is acceptable.

F1.1.3 The earthing, ducting and certification process for panels and electrical installations shall comply with Severn Trent Water standard ME37 and the various DSEAR associated electrical model approaches contained within the Severn Trent Water Design Manual.

DSEAR requirements – prior to commissioning and handover of the pumping station to Severn Trent Water the following DSEAR requirements must be complied with:-

Where hazardous zone is classified as ST-Zone BZ - a certificate of installation and the earth bonding certificate must be submitted to Asset Adoptions. Blank copies of these certificates for use by the developer/his contractor can be obtained from the Asset Adoptions offices.

For the other statutory hazardous zones please contact Severn Trent Water.

F1.2 Operation and maintenance documentation

F1.2.1 In addition to the specified information identified in Sewers for Adoption 7th Edition Severn Trent Water require 3 copies of the pumping station maintenance manual. These shall contain record drawings, wiring diagrams and pump details.

F2 PUMP SPECIFICATION

F2.1 Introduction

F2.1.1 The Sewage Pumping Station (SPS) may have to be provided with a pump which can accommodate low flows from light rainfall as well as pumps needed to cope with flows from the critical storm event.

F2.3.4.2 Auto Coupling System (ACS)

F2.3.4.2e The duck foot should be able to be removed/replaced from within the wet well. Captive bolts/studs should be able to be replaced.

F2.3.10 MOTORS

F.2.3.10.4 STARTING

F.2.3.10.4.1 To ensure air changes in the wet well and prevent retention under normal operating conditions there will be at least one pump start in a 24 hour period.

F2.3.10.5 ENCLOSURES & COOLING

F2.3.10.5.1 Severn Trent Water requirement is for no moisture to enter the motor housing during the life of the bearing

F.2.3.14 PUMP UNIT LIFTING ARRANGEMENTS

F.2.3.14.1 GENERAL

Lifting Operations (Davit Assembly)

For pumps up to 334kg gross weight a 500kg davit system must be supplied, this allows a safety factor of 50% to allow for lifting accessories / pump chains / breaking out forces / ragging, fat and grit deposition.

Davit sockets installed may be grouted / surface or wall mounted and should be of galvanised finish. 500kg davit installations must be able to support a standard 65mm pinned davit assembly and have the ability to incorporate a load cell as part of the lifting operation. All sockets shall be installed level and positioned to enable davit to be centred over the load whilst clearing any hand railing, guard railing or other obstruction.

Note: - For pump installations above the 334 kg Gross weight limit lifting options / practices must be done through consultation with Severn Trent Water at the design stage.

A lifting gantry will be required for lifting pumps heavier than 334 kg. At design stage provision should be made to ensure there is sufficient clearance between the cover slab and the bottom of the pump when lifting the pump out using a load cell and chain block or electric winch.

F.2.3.14 Pump Unit Lifting Arrangements

F.2.3.14.1 General

Severn Trent Water's preferred method of lifting is via the Lifting Location System (LLS). The LLS is suitable where the well is $\leq 7.5\text{m}$ in depth and each pump weighs $\leq 500\text{kg}$.

The LLS comprises of:-

- A stainless steel pvc coated wire guide rope terminated at both ends with a steel carbine hook with screw gate, secured with a crimped copper ferrule.

Attached to:-

- Two stainless steel eye bolts fixed in an easily accessible position at the top of the wet well and spaced apart such that the wire rope forms a 'V' shape with the load. When in use the guide rope is used to locate a specially designed hook directly onto the load

Where the wet well is $>7.5\text{ m}$ in depth (total height of lift from block to pump handle must not be more than 9 m) or the load is $>$ than 500 kg then fixed stainless steel lifting chains shall be supplied. Chains shall be short

link welded and manufactured from Grade 50, AISI 316 Stainless Steel to BS EN 818 (DIN766). Chains shall be provided with a larger diameter oval master links positioned at each end and at 1000mm centres. This larger link should have a minimum internal diameter of 50 mm (500 kg chains) or 60mm (1000kg chains) and be able to accommodate two lifting hooks.

Shackles shall be manufactured from AISI 316 Grade Stainless Steel. The lifting shackle attached to the pump must incorporate an extended pin and nylock nut to prevent loosening as a result of vibration.

Chains and shackles installed shall meet all the necessary requirements so as to produce a minimum two yearly Written Scheme of Examination. All chains and shackles should be individually tagged with a unique Severn Trent Water asset ID along with SWL and manufacturer batch ID.

Each chain shall be supplied with a test certificate and CE marked including chain type.

Each shackle shall be supplied with a test certificate.

F3 ELECTRICAL SPECIFICATION

F3.1 Scope

F3.1.1d An electromagnetic flowmeter is required on all Type 3 and Type 4 pumping stations

F3.2 General

F3.2.1.5 Severn Trent Water will only accept registered contractors.

F3.2.1.9 A lockable TP&N isolator shall be installed between the DNO fuses and the control panel. This isolator enables the control panel to be electrically isolated without the supply fuses being withdrawn.

F.3.2.2.3 For ST Zone BZ installations, labels nominal size 50 mm x 100mm with the text "ST Zone BZ" (White, Black, White) shall be installed on :

The control panel door
The kiosk door

For labelling requirements for the other statutory zones please consult with Severn Trent Water

F3.3 Electrical Assembly

F3.3.1 General

F3.3.1.2 Where Form 2 construction is utilised lockable isolators for each individual pump shall be provided on the panel door.

F3.3.5.3 Identification of Wiring

F3.3.5.3.4 The colours of wiring insulation shall conform to the current Severn Trent Water Engineering Specification ME1A. Copies can be obtained from Severn Trent Water.

F3.3.9 Telemetry Signals

Severn Trent Water operates a telemetry system to monitor and control remote sites, processes and equipment. The configuration, connection and commissioning of all signals used on this telemetry system shall conform to a standard arrangement to ensure consistency of application and response to issues.

A list of signals required by Severn Trent Water to effectively monitor a pumping station is detailed in Severn Trent Water 'Telemetry Signal Provision Standard'. The signals are derived from Severn Trent Water Remote Asset Management Policies (RAMPs) and use is **mandatory** for all sites, processes and equipment connected to the Severn Trent Water telemetry system.

The latest version of the Telemetry Signal Provision Standard' should be obtained from Severn Trent Water New Connections Team:

new.connections@severntrent.co.uk Tel: 0800 707 6600

F3.3.10 Ultrasonic Level Controller (ULC) Specification

F3.3.10.1 Normal Operation

F3.3.10.1.2 The control of the scour cycle will allow for adjustment in frequency so that the scour frequency can be optimised.

F3.3.10.3 Functionality

F3.3.10.3.13 The ULC shall be capable of deriving a 'time to spill' signal

F3.3.10.3.14 The ULC shall be capable of initiating a remote reset

F3.4.5.4 Connection of Pump unit cables

F3.4.5.4.1 For secure sites each pumpset cable shall be connected to its associated control panel cable by means of an above ground, free standing junction box on lockable galvanised steel uprights, adjacent to the wet well at a

nominal height of 1m, fitted with barriers for segregating cables with different operating voltages.

F3.4.5.4.2 For non secure sites then cabling shall be provided via ducts direct to the kiosk. The distance between the panel and the wet well is expected to be less than 5 metres.

F.3.3.8.2 Pump unit failure (initiated by hard wired pump unit protection systems)

F.3.3.8.2.8 Auto reset must only be applied when the pump is submerged and not exposed to a sewer derived atmosphere.

F.3.3.8.6 Low Flow Detection

Low flow detection is to be provided using an electro magnetic flowmeter. Low flow circuit shall operate when the flow in the rising main is below the pre-set low flow cut off value. With the pump running and after an adjustable time delay if the flow in the rising main has not developed to a pre-set adjustable value (nominally set at 10% of design flow per pump it shall generate a low flow trip which shall stop the pump and contribute to a pumped failed signal to telemetry. The second pump shall then be permitted to start under normal standby level control.

A low flow indicator light shall be provided on each starter door of the panel. The low flow signal shall be latched requiring attendance at site to reset via a common reset or automatically via the auto reset system.

Low flow trip shall be inhibited during the scouring cycle by means of the relevant timer settings confirmed during commissioning.

F3.3.10 Ultrasonic Level Controller (ULC) Specification

F3.3.10.1 The level control unit shall provide signals or control at the following:

Level DPH	Start Duty Pump
Level DPL	Stop Duty Pump
Level APH	Start Assist/standby pump
Level APL	Stop Assist/standby pump

None of the levels DPH, DPL, APH and APL shall be coincident.

F3.4.1.5 Junction Boxes

Junction boxes shall not be installed in wet wells irrespective of the DSEAR zone classification. If junction boxes are required they shall be mounted upon suitable up stands or in a below ground junction box chamber within a suitably IP rated enclosure.

F3.4.4 Installation of Cables

F3.4.4.5c The pump set cables require two ducts to be provided, each 100 mm in diameter.

F3.4.4.5e The telemetry cable requires one duct to be provided, 100 mm in diameter

F3.4.4.6 All ducts to and from a hazardous area (including SEVERN TRENT WATER -Zone BZ) are to be clearly identified by use of pink paint (BS4800 02 C 37) and labelling at the ends of ducts. Paint to be applied in a square around the end of each duct as detailed below,

Labelling is required to be installed adjacent to the ducts and shall state the following:

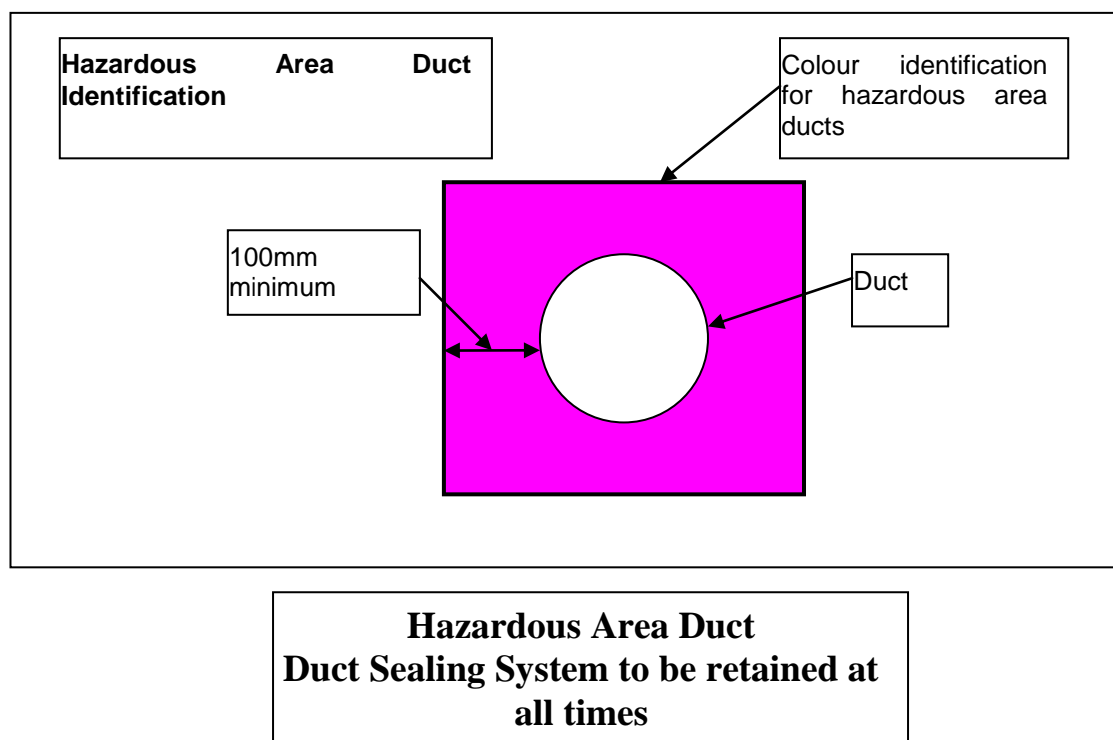

F.3.4.5.4 Connection of Pump unit Cables

Sealing of ducts - Duct connections into hazardous areas shall be provided with a means to ensure vapours, products, gases etc do not migrate into areas inappropriately. Severn Trent Water uses a methodology based upon “block and bleed” where the duct is provided with a block or inhibit to the flow of the possibly hazardous substance and a means by which any hazardous substance which bypasses the “block” is allowed to dissipate safely. See sketch and sealant detail below.

Ducts leaving a hazardous area or a Severn Trent Water Zone BZ and entering directly into a kiosk shall do so in a separate compartment which shall be sealed from the rest of the kiosk to IP55 rating and ventilated to

atmosphere. The ducts shall be sealed at the entrance into the compartment.

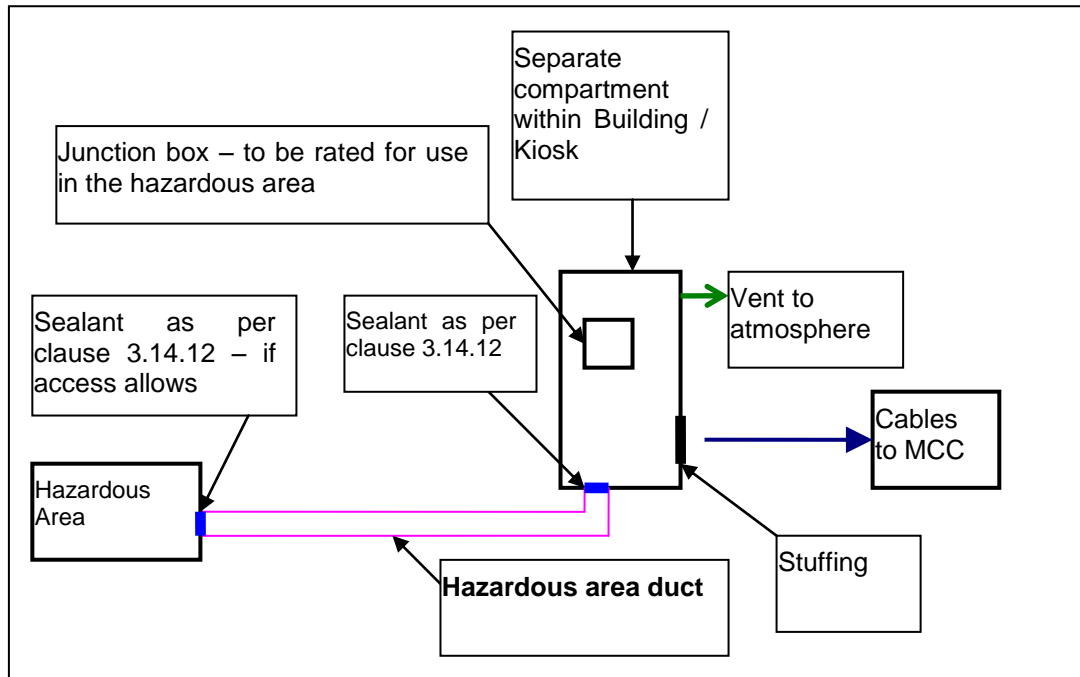

Ducts leaving a hazardous area or a Severn Trent Water Zone BZ and delivering cables to a junction box or a kiosk on a stand shall be sealed as they exit the ground; cables are required to pass through a minimum unobstructed air gap of 300 mm before entering the enclosure.

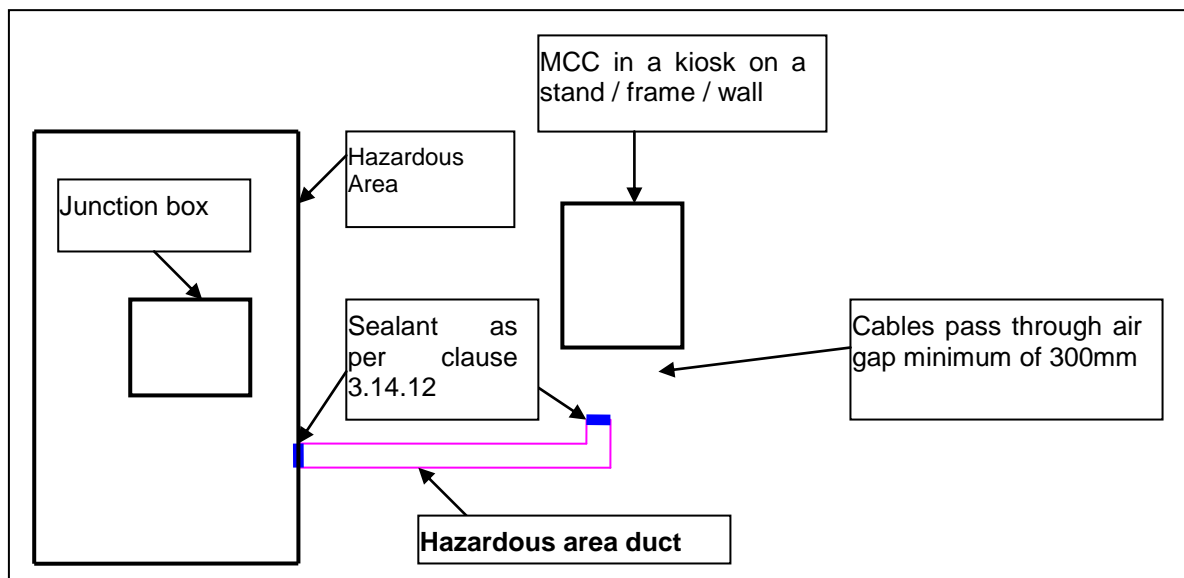

A proprietary duct or cable transit sealing system which ensures Lloyds certified minimum 1 bar gastight and 2.5 bar watertight seal and age tested for 50 years shall be used. This system shall consist of thermoplastic 60 mm long tubular water resistant split sleeves and a silicone based fire rated, water and gastight sealant as shown below. The insert sleeves shall be used to ensure cable separation and to pack any free space in the

penetration allowing for easy addition/removal of future cables. Sealant shall be applied to the face of the penetration ensuring a pressure tight seal is maintained, sealant to be applied to a minimum depth of 20 mm. The system shall be installed in accordance with the manufacturer's installation instructions.

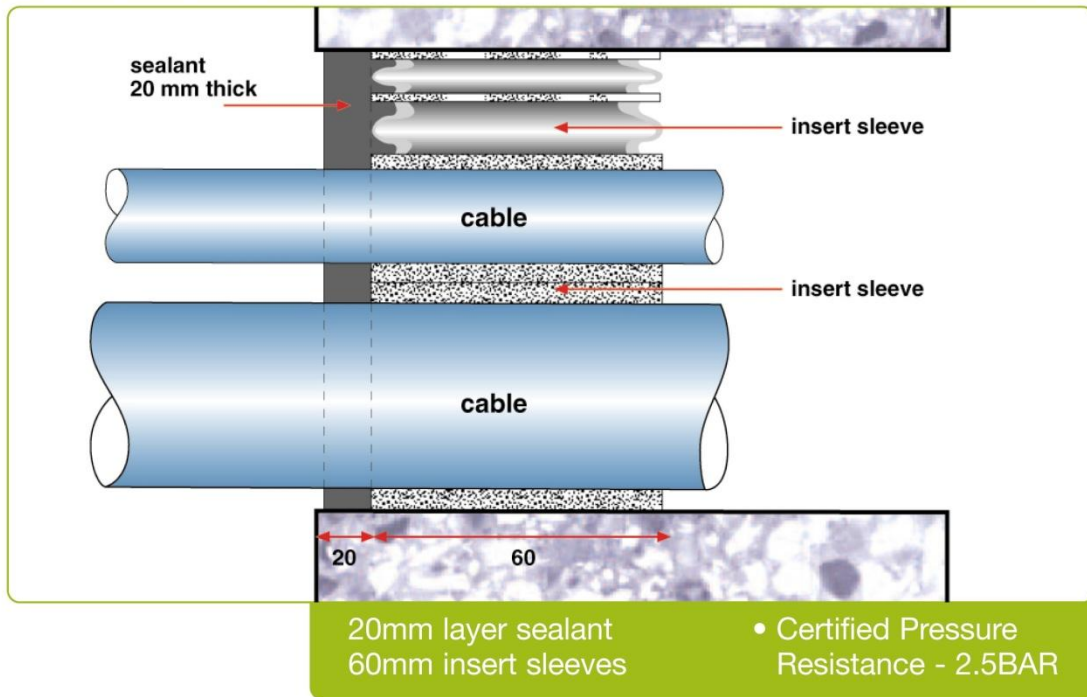

F.3.4.6 Earthing and Bonding

F.3.4.6.1 General

F.3.4.6.1.1 Testing - The earth leakage current for each completed installation shall be tested and recorded on the Earthing and Bonding Certificate. The current shall not be greater than 50mA.

The facility for non disconnection type testing shall be provided in the earth bonding installation to ensure that each equipotential bonding circuit can be tested. Each equipotential bond shall have a resistance of less than 1 Ohm.

F.3.4.6.1.2 TN-C-S in addition to the TN-C-S (PME) earthing system an isolating transformer shall be required. This installation shall include a local earth electrode.

This sketch provides an indication of intent from which the detail design may be developed.

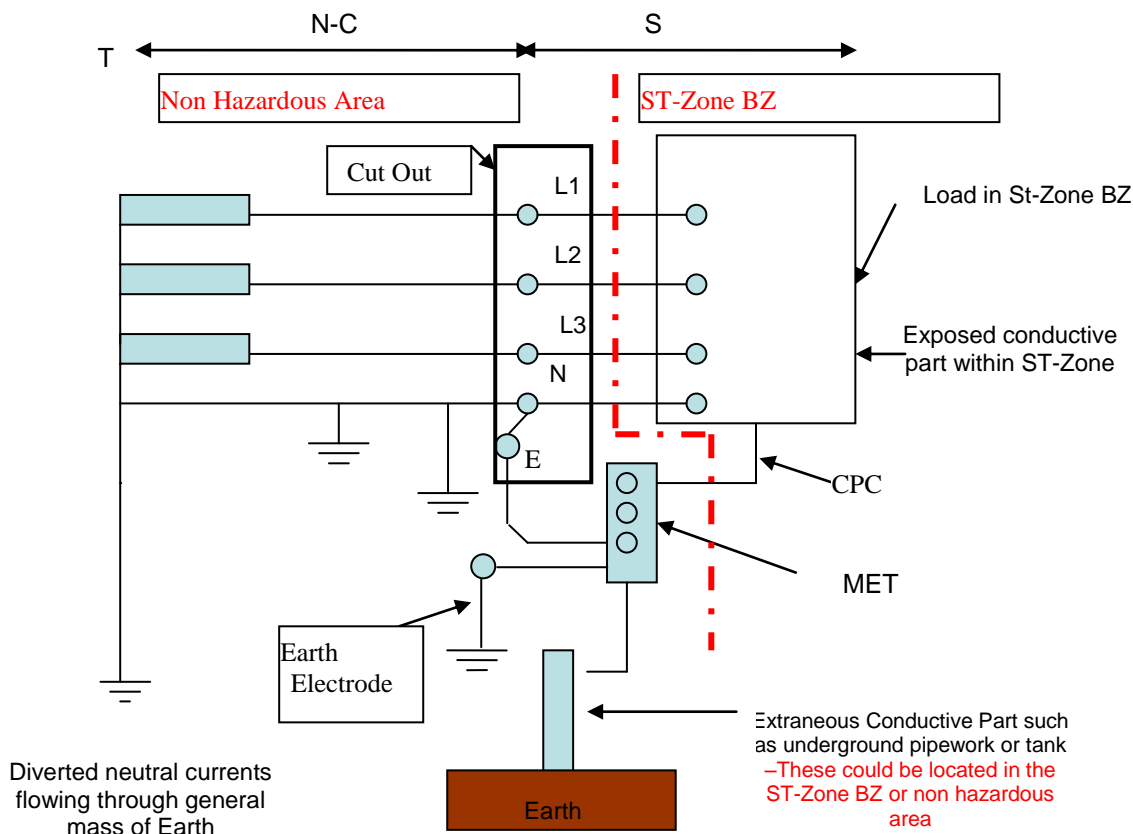

F.3.4.6.2 Generator Connection facilities – an earth electrode system is required as part of the electrical installation. It shall be designed to be utilised for this purpose and for earthing of the hazardous area.

Earth Electrodes are to be selected and sized in accordance with BS7430 Table 4. Earth resistance should not exceed 20 Ohms. The earth resistance shall be measured and recorded on the Certificate of Earthing and Bonding.

F.3.4.6.3 Bonding

F.3.4.6.3.1 General

F.3.4.6.3.1.1 Installation Requirements – PVC coated copper tape or cable shall be used for all bonding applications and shall be unbroken at intermediate points (refer to IEE Earthing and Bonding Guidance Note 8 Section 5.2)

The size of earth conductors is required to be calculated in accordance with the requirements of BS 7671 and shall be the same size as the phase conductors as a minimum.

Each point of connection shall be protected using an anti corrosion and sealing product.

F.3.4.6.3.2.1 Equipotential Bonding System – All exposed and extraneous-conductive parts of the installation within the hazardous area shall be connected to the equipotential bonding system on a separate earth bar as detailed in the sketch below.

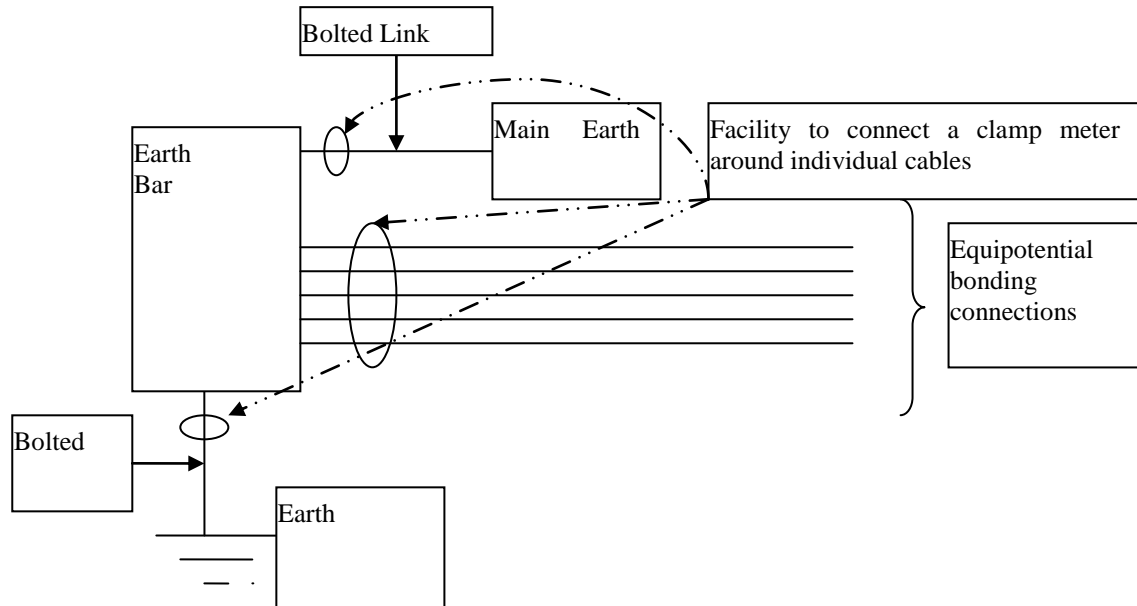
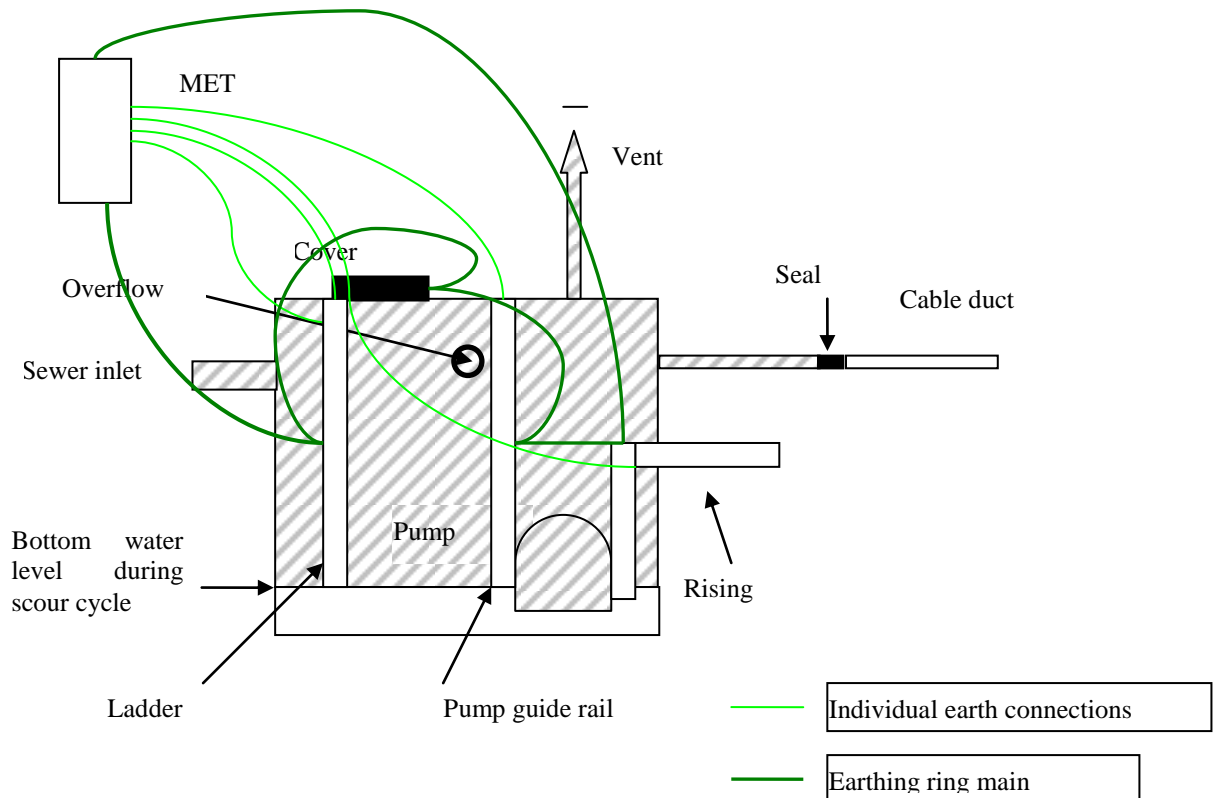

Figure 1. Earthing System

The earth bar shall be connected to the main earth terminal using a bolted link.

If the connection points are not readily accessible each item shall be connected separately to the earth bar twice, each connection point is required to be separate. Alternatively one individual connection and an earthing ring main may be installed. If a ring main is utilised Continuity of the main equipotential bonding conductor shall be maintained (refer to IEE Earthing and Bonding Guidance Note 8 Section 5.2)

This is required to ensure that a poor connection can be identified when tested. A typical example of this is shown in the sketch below.



F.3.4.6.3.3 Supplementary Equipotential Bonding

F.3.4.6.3.3.1 Supplementary Equipotential Bonding – This should be carried out as required to ensure compliance with BS 7671 and with reference to IEE Earthing and Bonding Guidance Note 8.

F3.5 Instrumentation

F3.5.1 Flowmeter Specification

F3.5.1 The flow transmitter connected to the flow sensor shall include the following features

- a) Minimum 4 output relays
- b) Programmed parameters stored in non volatile memory
- c) Integral LCD display includes level, relay status and programming data with display being interactive in the programming mode
- d) 110V ac input
- e) 4-20 mA analogue signal output capability with a 750 ohms loading
- f) Pulse output capability to give totalised flow output
- g) Proven use within the waste water industry and suitable for out door installation rated at IP68

- F3.5.1a** Electromagnetic flowmeter shall be designed and installed in accordance with BS EN ISO 6817
- F3.5.1b** It shall be equipped with a flow sensor and a separate converter (transmitter) which shall be installed remotely from the flow sensor
- F3.5.1c** The flow sensor shall not incur a hydraulic head loss greater than 0.5 m when conveying maximum flow and shall not contain obstructions liable to restrict flow.
- F3.5.1d** Flow sensors shall be protected to BS EN 60529 – IP 68 (5 m depth of submergence). Signal converters shall be protected to BS EN 60529 – IP 65
- F3.5.1e** All equipment shall be suitable for operation in ambient temperature -10C to +55C. In addition, signal converters installed outdoors shall be protected from the effects of wind-chill and direct sunlight.
- F3.5.1f** The overall accuracy, as defined by WIS 7-03-01 shall be 1%. The flow sensor shall be suitably rated for the range of pressures within the installation. In addition it shall be capable of withstanding a pressure equal to twice the normal operating pressure for a period of one minute without affecting the overall accuracy on return to normal rated pressure
- F3.5.1g** Flowmeter flanges shall be to BS EN 1092 part 2
- F3.5.1h** The input voltage to the flowmeter shall be 110V a.c. Local rate of flow indication shall be provided by a digital LCD indicator which, together with a totaliser, shall be mounted integral with, or adjacent to, the signal converter. In addition, a pulsed output signal and an isolated analogue signal shall be provided. The 4-20 mA analogue signal shall be linearly proportional to the flow rate. The signal converter shall be connected to the flow sensor by a suitably unjointed length of cable
- F3.5.1i** The flowmeter shall be installed in accordance with the manufacturer's recommendations and the certification requirements. The flow sensor shall be installed with all necessary earthing electrodes, gaskets and earthing straps and be bonded to earth. Upon completion of the installation of the flow sensor, any spare cabling shall be left neatly coiled and clipped.
- F3.5.1j** The Developer shall supply a calibration certificate with the flowmeter that shall be issued by a NAMAS calibration laboratory. In addition details of the methods to be used for carrying out in-situ validation checks shall be provided.

The full SEVERN TRENT WATER M & E specification for electromagnetic flowmeters can be obtained from Severn Trent Water.

F3.6 Telemetry Outstation

- F3.6.1** Severn Trent Water can offer to install and commission the telemetry system. There is a standard charge for this service. The Developer should contact Severn Trent Water New Connections Team for further details: new.connections@severntrent.co.uk Tel: 0800 707 6600